

# Wiring Instructions

## **WARNING**

To prevent **SERIOUS INJURY** or **DEATH** from electrocution:

- Power **MUST NOT** be connected until instructed.
- **NO** exposed part of the wire should be visible outside of the terminal for proper connection.



**\* VERY IMPORTANT! \***

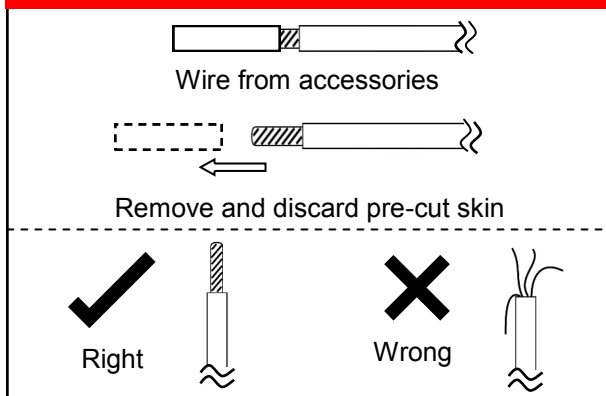

**Fig. 1**

In the following section, the **Photo Eye Safety System** and **Push Button** will be connected to the **Opener**. Please read and understand the wiring instructions before connecting wires.

1. Remove the pre-cut skin on the open end of wire from accessories. Wires **MUST NOT** be frayed. Wires must be connected as shown in Fig.1.
2. To connect a wire to an assigned terminal, use a small “flat head” screwdriver to push in the orange tab on the Wire Terminal as shown in Fig.2.
3. Insert approximately 1/2” (13mm) of the wire into the terminal while pushing in the tab as shown in Fig.2. Release the orange tab to lock wire in place.
4. Each accessory requires a pair of terminals. Each pair of terminals **MUST** be connected with one white wire and one striped wire (non-polarized) from the **SAME** accessory as shown in Fig.2.
5. Check for proper connection by gently pulling on the wire. The wire should not come out of the terminal. **NO** exposed part of the wire should be visible outside of the terminal.
6. Use the insulated staples provided to secure the wires to the wall and/or ceiling. Be careful not to damage the wires while securing the staples.

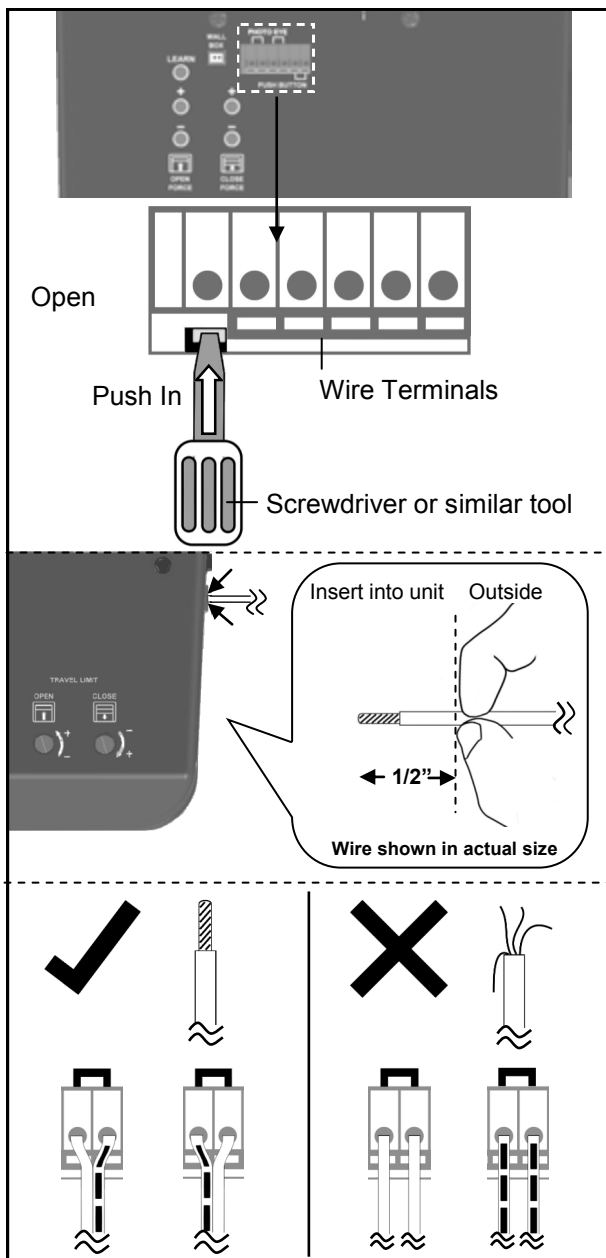

**Fig. 2**

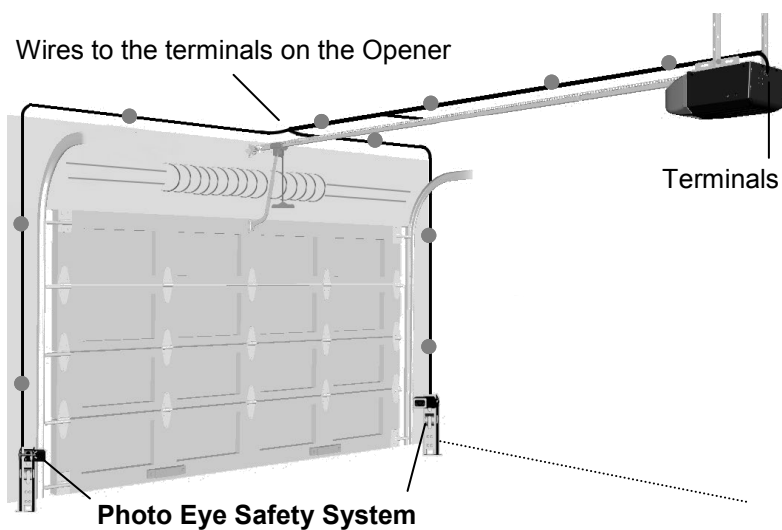

● Suggested placement of insulated staples

# Connecting Photo Eye Safety System

## **WARNING**

To prevent **SERIOUS INJURY** or **DEATH** from electrocution:

- Power **MUST NOT** be connected **BEFORE** Photo Eye Safety system is connected and aligned.
- The Opener will not operate until the Photo Eye Safety System is properly connected and aligned.
- Install the Photo Eyes **NO** higher than 6" (15cm) above the floor.



No part of garage door or other objects should obstruct the Photo Eye Safety System during door-closing.

**NOTICE: The opener will not close until the photo eyes are installed. Photo eyes are required by federal law to be installed on all openers. The opener will not work properly using photo eyes from another brand of opener and may disable the safety system.**

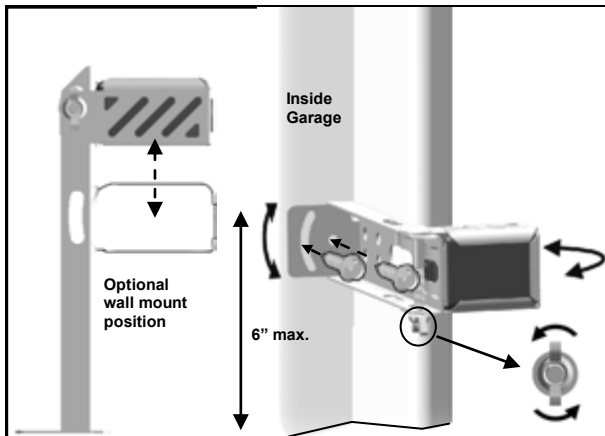

**Fig. 1 (Wall-Mount)**

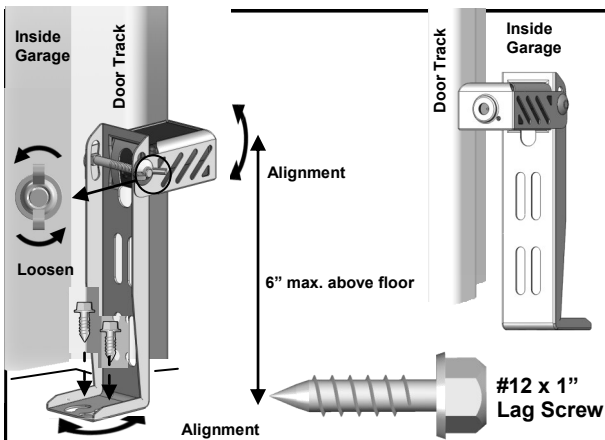

**Fig. 2 (Floor-Mount)**

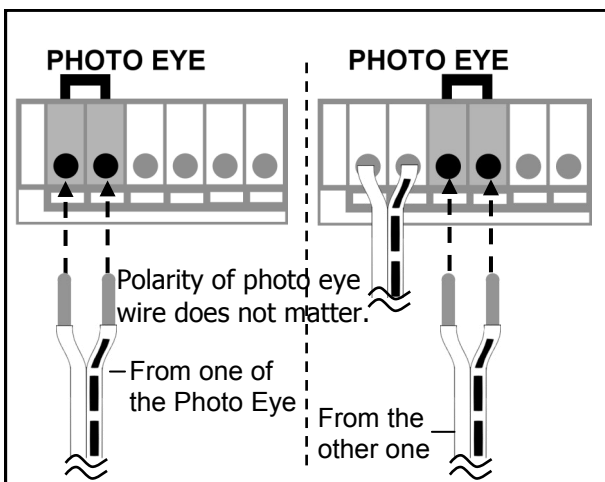

**Fig. 3**

## About the Photo Eye Safety System

The Photo Eye Safety System provides protection against entrapment while the door is closing. When properly connected and aligned, the Emitter Photo Eye emits an invisible infrared light beam while the Sensor Photo Eye monitors that beam.

If the beam is obstructed during door-closing, the entrapment protection will be triggered and the door will stop and reverse to the open position. The courtesy light will flash for 30 seconds indicating an obstruction.

## Installing The Photo Eye Safety System

### Wall-Mounting

1. Place the Photo Eyes facing each other on each side of the garage door. Position the sensors so they are no higher than 6" (15cm) above the floor, as shown in Fig.1.
2. Drill 3/16" holes using the mounting holes on the Bracket as a template. Secure with #12 x 1" Lag Screws (provided).
3. Be sure brackets, when mounted, are **NOT** in contact with the door track.
4. If necessary use the Optional Wall-mount Position (Fig.1) to better fit your door-track and improve obstacle avoidance. To adjust the position, loosen the wing nut, disassemble the Bracket and move the Photo Eye to the lower position on the holder.
5. If necessary, align the Photo Eyes by loosening the wing nut. (This step may be further required in **Aligning the Photo Eye Safety System** on page 16.)

### Alternative Floor-Mounting

1. Place the Photo Eyes facing each other on each side of the garage door, as shown in Fig.2.
2. If attaching to concrete, secure the Photo Eyes using concrete anchors and bolts (not provided).
3. Be sure brackets, when mounted, are **NOT** in contact with the door track.
4. If necessary, align the Photo Eyes by loosening the wing nut. (This step may be further required in **Aligning the Photo Eye Safety System** on page 16.)

### To Connect Photo Eye Safety System

1. Connect a pair of wires from either one of the Photo Eyes to a pair of "PHOTO EYE" terminals on the rear of the Opener as shown in Fig. 3. Refer to **Wiring Instructions** on page 13 for proper connections.
2. Repeat step above to connect the other Photo Eye.
3. Refer to **Wiring Instructions** on page 12 to ensure wires are connected properly.

# Connecting Push Button

## **WARNING**

To prevent **SERIOUS INJURY** or **DEATH** from electrocution:

- Power **MUST NOT** be connected until instructed.

To prevent **SERIOUS INJURY** or **DEATH** from using the Push Button and a closing door:

- Install the Push Button within sight of the door at a minimum height of 5 feet (1.5m) above the floor. Make sure it is out of the reach of children and moving parts of door and hardware.
- **NEVER** permit children to access the Push Button or remote Transmitters.
- Operate the door **ONLY** when it is adjusted properly with no obstructions present and is in clear sight.
- **ALWAYS** keep a moving door in sight until it's completely closed.
- **NEVER** cross the path of a moving door.



**NOTICE: Use Performax brand push button only. Use of other brands of push buttons or buttons may cause issues or damage to your opener.**

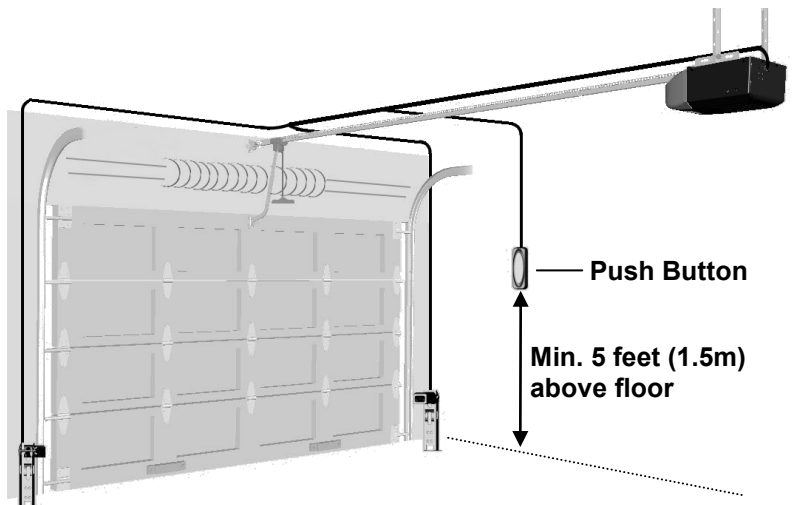
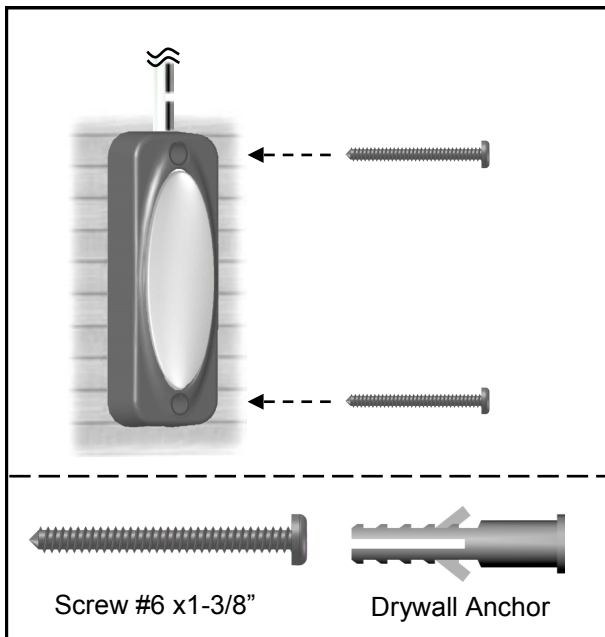

The Push Button is a wired, illuminated door control placed inside your garage.

### To install the Push Button:

1. Inside your garage, install the Push Button within sight of the door at a minimum height of 5 feet (1.5m) off the ground. Ensure it is installed out of the reach of children and free from the moving parts of the door and hardware.
2. With the "Bell" icon on the rear cover facing you, securely fasten it to a solid surface with 1" screws. If attaching to drywall or other hollow surface, drill 3/16" holes and use the provided Drywall Anchors.

### To Connect the Push Button to the Opener

Connect the pair of wires from the Push Button to the pair of "PUSH BUTTON" terminals on the rear of the Opener. Refer to **Wiring Instructions** on page 12 to ensure wires are properly connected.

